



Medical Power Supply
Low Acoustic Noise 1U size



PLUG & PLAY POWER
next generation power solution

FEATURES & OPTIONS

- Low Acoustic noise 39.8dBA
- EN60601-1 3rd edition approved
- Less than 300µA leakage current
- 150µA option available
- 4000VAC isolation
- Ultra high efficiency, up to 89%
- Extra low profile: 1U height (40mm)
- Plug & Play Power - allows fast custom configuration
- Individual output control signals
- All outputs fully floating
- Series / Parallel of multiple outputs
- Few electrolytic capacitors (all long life)
- 5V bias standby voltage provided
- Standard Xgen product options include:
Conformal Coating, Low Acoustic Noise, Low Leakage Current, Extra Ruggedisation, Connector, Cabling & Mounting options, Thermal Signals and Reverse Fans. See Section 4.10 for more information

APPLICATIONS INCLUDE

- Radiological imaging
- Clinical diagnostics
- Medical lasers
- Clinical chemistry

The XR family of low acoustic noise medically approved power supplies provides up to 600W in a slimline 1u x 260mm x 89mm package. Ideal for acoustic sensitive medical equipment, the XR family carries full safety agency approvals to EN60601-1 and UL60601-1 3rd Edition, meeting the stringent creepage and clearance requirements in this compact package. Providing up to 8 isolated outputs, the XR family is the most flexible power supply in its class and brings affordable configurable power to the 200-600W medical market.

The XR family consists of 3 *powerPac* models in 200W, 400W and 600W power levels. Each *powerPac* model may be populated with up to 4 *powerMods* selected from the table of *powerMods* shown below. Simply select your appropriate *powerPac* and *powerMods* to get your instant custom power solution.

This slimline product boasts unrivalled power density, providing significant system space savings. Combined with ultra-high efficiencies, the XR family provides system designers with flexible instant solutions that significantly shorten system design-in time.

powerMods

MODEL	V _{trim}	V _{min} V _{pot}	V _{nom}	V _{max}	I _{max}	Watts
Xg1	1.0	1.5	2.5	3.6	50A	125W
Xg2	1.5	3.2	5.0	6.0	40A	200W
Xg3	4.0	6.0	12.0	15.0	20A	240W
Xg4	8.0	12.0	24.0	30.0	10A	240W
Xg5	8.0	28	48.0	58.0	6A	288W
Xg7		5.0	24.0	28.0	5A	120W
Xg8 v1		5.0	24.0	28.0	3A	72W
Xg8 v2		5.0	24.0	28.0	3A	72W

powerPacs

	MODEL	Watts
XR	XRA	200W
	XRБ	400W
	XRC	600W

EFFICIENCY (typical)

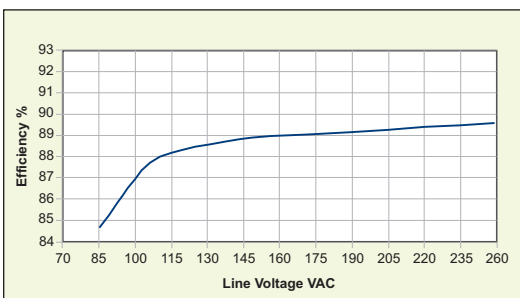

MECHANICAL SPECIFICATIONS

Note: See diagrams on pages 34-37

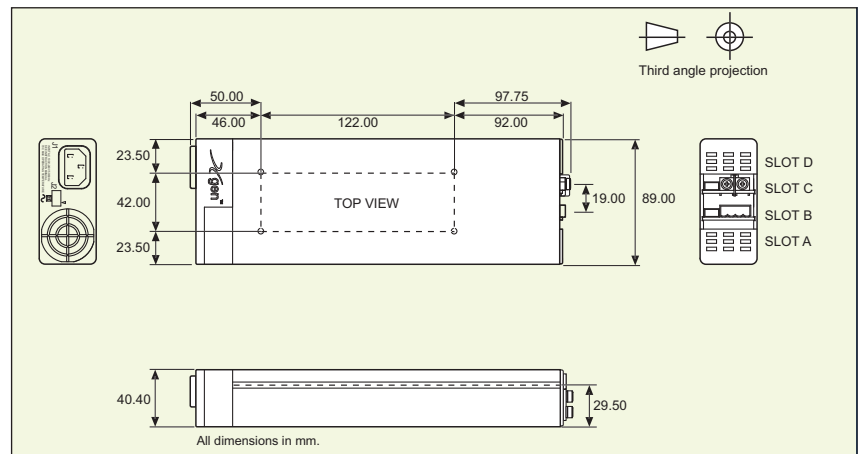

SPECIFICATION applies to configured units consisting of *powerMods* plugged into the appropriate *powerPac*

INPUT					
Parameter	Conditions/Description	Min	Nom	Max	Units
Input Voltage Range	Universal Input 47-440Hz	85 120		264 380	VAC VDC
Power Rating	XRA:200W, XRB:400W, XRC:600W See Section 4.11 for line voltage deratings				
Input Current	XRA XRB XRC	85VAC in 200W out 85VAC in 400W out 85VAC in 400W out	4.5 5.5 7.5		A A A
Inrush Current	230VAC, 25°C			50	A
Undervoltage Lockout	Shutdown	65		74	VAC
Fusing	XRA XRB XRC	250V 5 x 20mm 250V 5 x 20mm 250V 5 x 20mm		F5A HRC F6.3A HRC F8A HRC	
OUTPUT					
Parameter	Conditions/Description	Min	Nom	Max	Units
powerMod Power	As per <i>powerMod</i> table				
Output Adjustment Range	Manual: Multi-turn potentiometer. As per <i>powerMod</i> table Electronic: See Section 4.6				
Minimum Load			0		A
Line Regulation	For ±10% change from nominal line			±0.1	%
Load Regulation	For 25% to 75% load change			±0.2	%
Cross Regulation				±0.2	%
Transient Response	For 25% to 75% load change Voltage Deviation Settling Time			10 250	% µs
Ripple and Noise	20MHz 100mV or 1.0% pk-pk				
Overvoltage Protection	1st level: Vset Tracking. 2nd level: Vmax (Latching)	110		125	%
Overcurrent Protection	Straight line with hiccup activation at <30% of Vnom See Section 4.6	110		120	%
Remote Sense	Max. line drop compensation. (except Xg7, Xg8)			0.5	VDC
Overshoot				2	%
Turn-on Delay	From AC in and Global Enable / powerMod Enable			700 / 6	ms
Rise Time	Monotonic			5	ms
Hold-up Time	For nominal output voltages at full load	20			ms
Output Isolation	Output to Output / Output to Chassis	500 / 500			VDC
GENERAL					
Parameter	Conditions/Description	Min	Nom	Max	Units
Isolation Voltage	Input to Output Input to Chassis	4000 1500			VAC VAC
Efficiency	230VAC, 600W @ 24V		89		%
Safety Agency Approvals	EN60601-1, UL2601-1, CSA601-1 UL File No. E230761				
Leakage Current	250VAC, 60Hz, 25°C 250VAC, 60Hz, 25°C Option 04			300 150	µA µA
Signals	See Section 4.9				
Bias Supply	Always on. Current 250mA. 500mA option available	4.8	5.0	5.2	VDC
Reliability	Failures per million hours at 40°C and full load <i>powerMod</i> See Section 4.12. <i>powerPac</i> excludes fans <i>powerPac</i>			0.958 0.92	fpmh fpmh
EMC					
Parameter	Standard		Level		Units
Emissions					
Conducted	EN55011, EN55022, FCC		Level B		
Radiated	EN55011, EN55022, FCC		Level B		
Harmonic Distortion	EN61000-3-2 Class A		Compliant		
Flicker & Fluctuation	EN61000-3-3		Compliant		
Immunity					
Electrostatic Discharge	EN61000-4-2		Level 2		
Radiated Immunity	EN61000-4-3		Level 3		
Fast Transients-Burst	EN61000-4-4		Level 3		
Input Line Surges	EN61000-4-5		Level 3		
Conducted Immunity	EN61000-4-6		Level 3		
Voltage Dips	EN61000-4-11		Compliant		
ENVIRONMENTAL					
Parameter	Conditions/Description	Min	Nom	Max	Units
Operating Temperature		-20		+70	°C
Storage Temperature		-40		+85	°C
Derating	See Section 4.11 for full temperature deratings				
Relative Humidity	Non-condensing	5		95	%RH
Acoustic Noise	Measured from distance of 1m		39.8		dBA
Shock	3000 Bumps, 10G (16ms) half sine				
Vibration	1.5G	10		200	Hz

NOTES

1. This product is not intended for use as a stand alone unit and must be installed by qualified personnel.
2. The specifications contained herein are believed to be correct at time of publication and are subject to change without notice.
3. All specifications at nominal input, full load, 25°C unless otherwise stated.
4. When powering inductive or capacitive loads, it is recommended to use a blocking diode on the output.
5. For section references above go to the Xgen Designers Manual.

Xgen Flexibility and Signals

For detailed information please refer to the Xgen Designers' Manual which is available on-line or contact Excelsys.

Voltage Adjustment

Output Voltage can be adjusted in a number of ways:

1. On board multi turn potentiometer
2. Remote resistive programming (via Vtrim pin)
3. Remote voltage programming (via Vtrim pin)

Current Limit Adjustment

Output current limit can be Straight line or Foldback and can be adjusted via Itrim pin.

Parallel Connection

To achieve increased current capacity, simply parallel outputs using the standard parallel links. Excelsys 'wireless' sharing ensures that current hogging is not possible. To parallel connect outputs:

1. Switch on IShare switch to ON on powerMods.
2. Connect Negative parallel link.
3. Adjust output voltages of powerMods to within 5mV of each other.
4. Connect Positive Parallel Link.

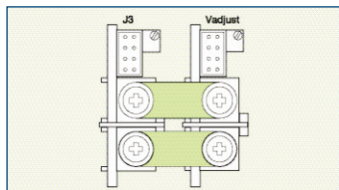

Parallel Links available to order. Part Number XP1

*Certain applications may require military grade potentiometer or fixed resistors - consult Excelsys for details.

Series Connection

To achieve increased output voltages, simply series outputs using standard series links, paying attention to the requirements to maintain SELV levels if required in your system.

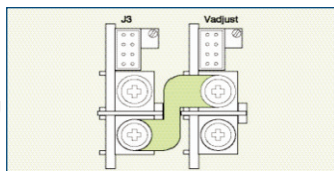

Series Links available. Part Number XS1

Remote Sensing

When the load is remote from the power supply, the remote sense pins may be used to compensate for drops in the power leads. Where the power cabling contributes significant dynamic impedance, see Xgen series Designers' Manual.

Bias Voltage

A SELV isolated bias (always on) voltage of 5V @ 250mA (30mA on XCE and XVE models) is provided on J2 pin 2 relative to J2 pin 1 (common) and may be used for miscellaneous control functions. 5V @ 500mA available on request.

Inhibit/Enable

Inhibiting may be implemented either globally or on a per module basis (*powerPac* or *powerMod* inhibiting). Reverse logic (enabling) may also be implemented.

AC Fail

Open collector signal indicating that the input voltage has failed or is less than 80Vac. This signal changes state giving 5mS of warning before loss of output regulation.

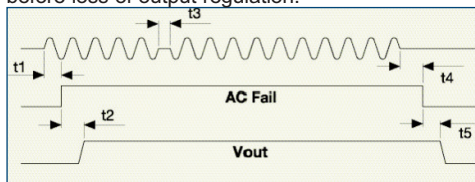

Power Good

Opto-Isolated output signal indicates that the *powerMod* is operating correctly and output voltage is within normal band.

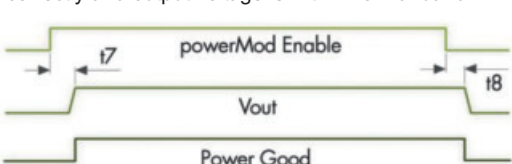

powerPac Options

Temperature Alarm (Option 01)

Open collector signal indicating excessive temperature has been reached due to fan failure or operation beyond ratings. This signal is activated at least 10ms prior to system shutdown.

Fan Fail (Option 01)

Open collector signal indicating that at least one of the *powerPacs* fans has failed. This does not cause power supply shutdown. The power supply will continue to operate until 10ms after the temperature alarm signal is generated.

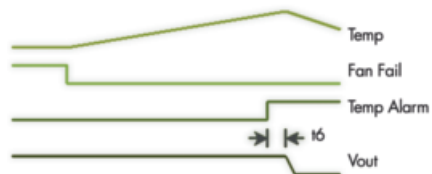

Reverse Fan (Option 02)

The Xgen Series is available with reverse air flow direction. Contact Excelsys for derating details.

Ultra Low Leakage Current (Option 04)

The Xgen is available with the option of Ultra Low Earth Leakage Current of <math><150\mu\text{A}</math> and is approved to EN60601-1 and UL60601-1 2nd and 3rd Editions

Conformal Coating (Option C)

The Xgen is available with conformal coating for harsh environments and MIL-COTs applications.

Ruggedised Option (Option R)

The Xgen is available with extra ruggedisation for applications that are subject to extremes in shock and vibration.

Input Cable Option (Option D)

3 Wire input mains cable. Input cables are 300mm in length and come supplied with fast connectors.

Signal Connector Pinout

Pin	J2 (powerPac)	J3 (powerMod) Xg1-Xg5 Type A	J3 (powerMod) Xg7 Type A	J3 (powerMod) Xg8 Type B
1	common	+sense	not used	-pg (V2)
2	+5V bias	-sense	not used	+pg (V2)
3		V trim	not used	inhibit (V2)
4	ac fail	I trim	common	common (V2)
5	fan fail*	+inhibit/enable	-pg	-pg (V1)
6	global enable	-inhibit/enable	+pg	+pg (V1)
7	temp alarm*	+power good	inhibit	inhibit (V1)
8	global inhibit	-power good	common	common (V1)

*Option 01 only

TYPE A Xg1-Xg7

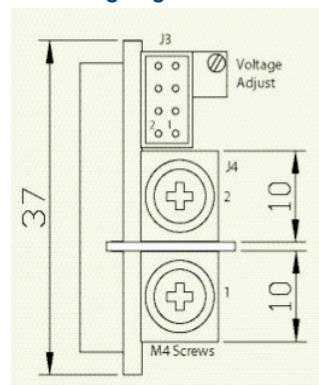

J4 Connector : M4 Screw

J3 Connector Mating Connector
Housing: Locking Molex 51110-0860
Non Locking Molex 51110-0850
Crimp Terminal: Molex p/n 50394

TYPE B : Xg8

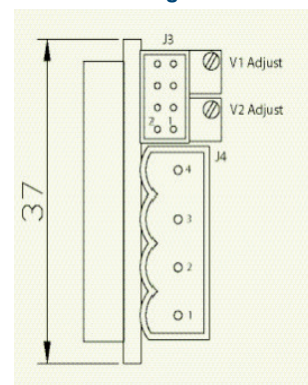

J4Connector : Camden 9200/4A
Würth Elektronik 691 352 710 004

J3 Connector Mating Connector
Housing: Locking Molex 51110-0860
Non Locking Molex 51110-0850
Crimp Terminal: Molex p/n 50394

Xgen Product Selector

The Xgen series of user configurable power supplies with its unique plug and play architecture allows system designers to define and build 'instant' custom power solutions with industry leading 17W/in³ power density and up to 90% efficiency.

Xgen powerPacs

The application specific 4 slot and 6 slot *powerPacs* provide up to 12 isolated DC outputs from 200W up to 1340W. The table below summarises the *powerPacs* by application and power level. Please refer to the specific product datasheets for full specifications.

Application	Slots	200W	400W	600W	700W	750W	800W	900W	1000W	1200W	1340W
Standard	4 Slot	XLA	XLB	XLC	XLD						
	6 Slot		XCA		XCB			XCC	XCD	XCE	
Medical	4 Slot	XMA	XMB	XMC	XMD						
	6 Slot		XVA		XVB			XVC	XVD	XVD	
Low Noise Standard	4 Slot	XKA	XKB	XKC							
	6 Slot		XQA					XQB		XQC	
Low Noise Medical	4 Slot	XRA	XRB	XRC							
	6 Slot		XZA					XZB		XZC	
Ultra Quiet Standard	4 Slot	XTA	XTB								
	6 Slot		XBA	XBB			XBC				
Ultra Quiet Medical	4 Slot	XNA	XNB								
	6 Slot		XWA	XWB			XWC				
Hi-Temp	6 Slot		XHA	XHB							

Xgen powerMods

High Efficiency Plug and Play DC output modules to provide a wide range of DC output voltages from 1.0V up to 58.0V.

MODEL	Vmin		Vnom	Vmax	Imax	Watts
	Vtrim	Vpot				
Xg1	1.0	1.5	2.5	3.6	50A	125W
Xg2	1.5	3.2	5.0	6.0	40A	200W
Xg3	4.0	6.0	12.0	15.0	20A	240W
Xg4	8.0	12.0	24.0	30.0	10A	240W
Xg5	8.0	24.0	48.0	58.0	6A	288W
Xg7		5.0	24.0	28.0	5A	120W
Xg8 v1		5.0	24.0	28.0	3A	72W
	v2		5.0	24.0	3A	72W

Standard Xgen product options include: Conformal Coating, Low Acoustic Noise, Low Leakage Current, Extra Ruggedisation, Connector, Cabling & Mounting options, Thermal Signals and Reverse Fans.



Configuring your Xgen

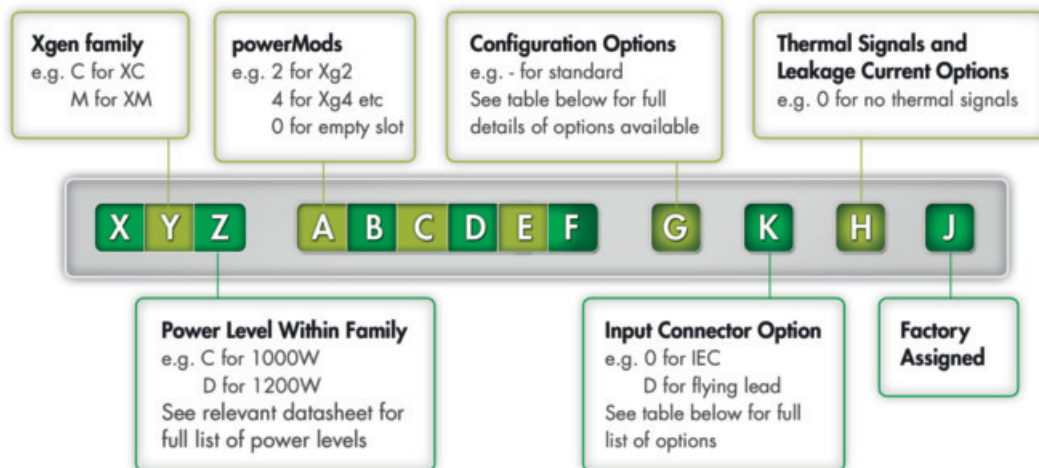

Example:
XVD234580-D4A contains
XVD *powerPac*:
1200W medically approved

Powermods
Xg2:5V/40A
Xg3:12V/20A
Xg4:24V/10A
Xg5:48V/6A
Xg8:24V/3A, 24V/3A

Option D: Input Cable option
Option 4: 150µA Leakage current option

A: Factory assigned unique identifier