

400W-1200W



**Medical Power Supply**  
Low Acoustic Noise 1U size



Medical Low Acoustic Noise



**PLUG & PLAY POWER**  
next generation power solution

**FEATURES & OPTIONS**

- Low Acoustic noise 42.7dBA
- EN60601-1 3rd edition Approved
- Less than 300µA leakage current
- 150µA option available
- 4000VAC isolation
- Ultra high efficiency, up to 89%
- Extra low profile: 1U height (40mm)
- Plug & Play Power - allows fast custom configuration
- Individual output control signals
- All outputs fully floating
- Series / Parallel of multiple outputs
- Few electrolytic capacitors (all long life)
- 5V bias standby voltage provided
- Standard Xgen product options include:  
Conformal Coating, Low Acoustic Noise, Low Leakage Current, Extra Ruggedisation, Connector, Cabling & Mounting options, Thermal Signals and Reverse Fans. See Section 4.10 for more information

**APPLICATIONS INCLUDE**

- Clinical diagnostic equipment
- Medical lasers
- Dialysis equipment

The XZ family of low acoustic noise medically approved power supplies provides up to 1200W in an extremely compact 1U x 260mm x 127mm package. Boasting industry leading power density of 15W/in<sup>3</sup> and efficiencies of up to 90%, the XZ family employs an innovative plug & play architecture that allows users to instantly configure a custom power solution in less than 5 minutes!

Ideal for acoustic sensitive medical applications the XZ family provides unmatched efficiency and high power density, made possible through the combination of low loss technologies and the best field-proven technologies in planar magnetics and surface mount electronics.

The XZ family consists of 3 *powerPac* models ranging in power levels from 400W to 1200W. Each model may be populated with up to 6 *powerMods* selected from the table of *powerMods* shown below.

All configurations carry full safety agency approvals, UL60601-1, EN60601-1 3rd Edition and are CE marked.

**powerMods**

| MODEL  | V <sub>trim</sub> | V <sub>min</sub> | V <sub>nom</sub> | V <sub>max</sub> | I <sub>max</sub> | Watts |
|--------|-------------------|------------------|------------------|------------------|------------------|-------|
| Xg1    | 1.0               | 1.5              | 2.5              | 3.6              | 41.6A            | 104W  |
| Xg2    | 1.5               | 3.2              | 5.0              | 6.0              | 33.2A            | 166W  |
| Xg3    | 4.0               | 6.0              | 12.0             | 15.0             | 16.67A           | 200W  |
| Xg4    | 8.0               | 12.0             | 24.0             | 30.0             | 8.33A            | 200W  |
| Xg5    | 8.0               | 28               | 48.0             | 58.0             | 5A               | 240W  |
| Xg7    |                   | 5.0              | 24.0             | 28.0             | 4.17A            | 100W  |
| Xg8 v1 |                   | 5.0              | 24.0             | 28.0             | 2.5A             | 60W   |
| v2     |                   | 5.0              | 24.0             | 28.0             | 2.5A             | 60W   |

**powerPacs**

| MODEL | Watts |
|-------|-------|
| XZA   | 400W  |
| XZB   | 900W  |
| XZC   | 1200W |

**EFFICIENCY (typical)**

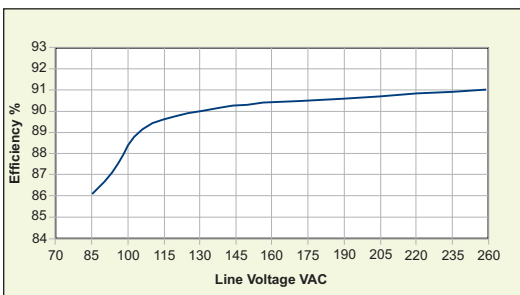

**MECHANICAL SPECIFICATIONS**

Note: See diagrams on pages 34-37

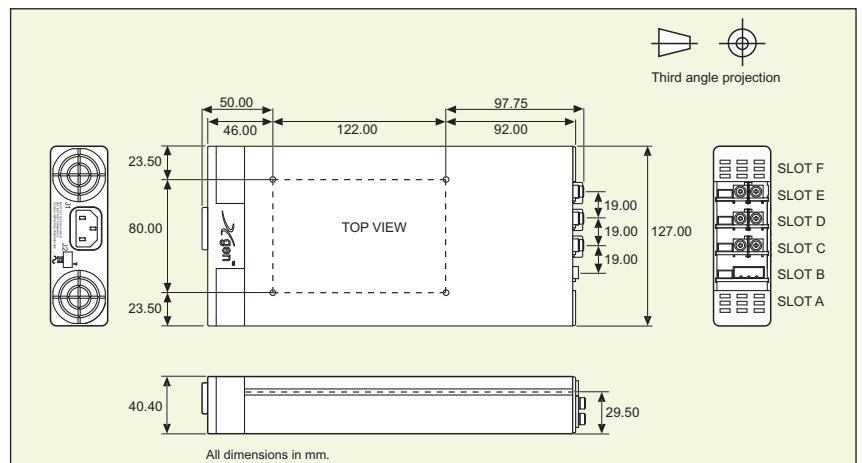

**SPECIFICATION** applies to configured units consisting of *powerMods* plugged into the appropriate *powerPac*

| INPUT                              |   |   |                                 |                |              |
|------------------------------------|---|---|---------------------------------|----------------|--------------|
| Parameter                          | Conditions/Description  | Min   | Nom                             | Max            | Units        |
| <b>Input Voltage Range</b>         | Universal Input 47-440Hz.   | 85<br>120   |                                 | 264<br>380     | VAC<br>VDC   |
| <b>Power Rating</b>                | XZA:600W, XZB:900W, XZC:1200W<br>See Section 4.11 for line voltage deratings                        |   |                                 |                |              |
| <b>Input Current</b>               | XZA<br>XZB<br>XZC   | 85VAC in 400W out<br>85VAC in 850W out<br>85VAC in 850W out | 7.5<br>11.5<br>11.5             |                | A<br>A<br>A  |
| <b>Inrush Current</b>              | 230VAC @ 25°C   |   |                                 | 25             | A            |
| <b>Undervoltage Lockout</b>        | Shutdown  | 65  |                                 | 74             | VAC          |
| <b>Fusing</b>                      | XZA<br>XZB<br>XZC   | 250V<br>250V<br>250V  | F8A HRC<br>F12A HRC<br>F12A HRC |                |              |
| OUTPUT                             |   |   |                                 |                |              |
| Parameter                          | Conditions/Description  | Min   | Nom                             | Max            | Units        |
| <b>powerMod Power</b>              | As per <i>powerMod</i> table  |   |                                 |                |              |
| <b>Output Adjustment Range</b>     | Manual: Multi-turn potentiometer. As per <i>powerMod</i> table<br>Electronic: See Section 4.6       |   |                                 |                |              |
| <b>Minimum Load</b>                |   |   | 0                               |                | A            |
| <b>Line Regulation</b>             | For ±10% change from nominal line   |   |                                 | ±0.1           | %            |
| <b>Load &amp; Cross Regulation</b> | For 25% to 75% load change  |   |                                 | ±0.2           | %            |
| <b>Transient Response</b>          | For 25% to 75% load change  |   |                                 | 10<br>250      | %<br>µs      |
| <b>Ripple and Noise</b>            | 20MHz 100mV or 1.0% pk-pk   |   |                                 |                |              |
| <b>Overvoltage Protection</b>      | 1st level: Vset Tracking. 2nd level: Vmax (Latching)  | 110   |                                 | 125            | %            |
| <b>Overcurrent Protection</b>      | Straight line with hiccup activation at <30% of Vnom<br>See Section 4.6                             | 110   |                                 | 120            | %            |
| <b>Remote Sense</b>                | Max. line drop compensation. (except Xg7, Xg8)  |   |                                 | 0.5            | VDC          |
| <b>Overshoot</b>                   |   |   |                                 | 2              | %            |
| <b>Turn-on Delay</b>               | From AC in and Global Enable / powerMod Enable  |   |                                 | 700 / 6        | ms           |
| <b>Rise Time</b>                   | Monotonic   |   |                                 | 5              | ms           |
| <b>Hold-up Time</b>                | For nominal output voltages at full load. XZA, XXB/XZC  | 20 / 15   |                                 |                | ms           |
| <b>Output Isolation</b>            | Output to Output / Output to Chassis  | 500 / 500   |                                 |                | VDC          |
| GENERAL                            |   |   |                                 |                |              |
| Parameter                          | Conditions/Description  | Min   | Nom                             | Max            | Units        |
| <b>Isolation Voltage</b>           | Input to Output<br>Input to Chassis   | 4000<br>1500  |                                 |                | VAC<br>VAC   |
| <b>Efficiency</b>                  | 230VAC, 1200W @ 24V   |   | 90                              |                | %            |
| <b>Safety Agency Approvals</b>     | EN60601-1, UL60601-1 3rd Edition, CSA601-1 UL File no. E230761                                      |   |                                 |                |              |
| <b>Leakage Current</b>             | 250VAC, 60Hz, 25°C<br>250VAC, 60Hz, 25°C Option 04  |   |                                 | 300<br>150     | µA<br>µA     |
| <b>Signals</b>                     | See Section 4.9   |   |                                 |                |              |
| <b>Bias Supply</b>                 | Always on. Current 250mA. 500mA option available  | 4.8   | 5.0                             | 5.2            | VDC          |
| <b>Reliability</b>                 | Failures per million hours at 40°C and full load<br>See Section 4.12. <i>powerPac</i> excludes fans |   |                                 | 0.958<br>0.946 | fpmh<br>fpmh |
| EMC                                |   |   |                                 |                |              |
| Parameter                          | Standard  |   | Level                           |                | Units        |
| <b>Emissions</b>                   |   |   |                                 |                |              |
| <b>Conducted</b>                   | EN55011, EN55022, FCC   |   | Level B                         |                |              |
| <b>Radiated</b>                    | EN55011, EN55022, FCC   |   | Level B                         |                |              |
| <b>Harmonic Distortion</b>         | EN61000-3-2 Class A   |   | Compliant                       |                |              |
| <b>Flicker &amp; Fluctuation</b>   | EN61000-3-3   |   | Compliant                       |                |              |
| <b>Immunity</b>                    |   |   |                                 |                |              |
| <b>Electrostatic Discharge</b>     | EN61000-4-2   |   | Level 2                         |                |              |
| <b>Radiated Immunity</b>           | EN61000-4-3   |   | Level 3                         |                |              |
| <b>Fast Transients-Burst</b>       | EN61000-4-4   |   | Level 3                         |                |              |
| <b>Input Line Surges</b>           | EN61000-4-5   |   | Level 3                         |                |              |
| <b>Conducted Immunity</b>          | EN61000-4-6   |   | Level 3                         |                |              |
| <b>Voltage Dips</b>                | EN61000-4-11  |   | Compliant                       |                |              |
| ENVIRONMENTAL                      |   |   |                                 |                |              |
| Parameter                          | Conditions/Description  | Min   | Nom                             | Max            | Units        |
| <b>Operating Temperature</b>       |   | -20   |                                 | +70            | °C           |
| <b>Storage Temperature</b>         |   | -40   |                                 | +85            | °C           |
| <b>Derating</b>                    | See Section 4.11 for full temperature deratings   |   |                                 |                |              |
| <b>Relative Humidity</b>           | Non-condensing  | 5   |                                 | 95             | %RH          |
| <b>Acoustic Noise</b>              | Measured from distance of 1m  |   | 42.7                            |                | dBA          |
| <b>Shock</b>                       | 3000 Bumps, 10G (16ms) half sine  |   |                                 |                |              |
| <b>Vibration</b>                   | 1.5G  | 10  |                                 | 200            | Hz           |

**NOTES**

1. This product is not intended for use as a stand alone unit and must be installed by qualified personnel.
2. The specifications contained herein are believed to be correct at time of publication and are subject to change without notice.
3. All specifications at nominal input, full load, 25°C unless otherwise stated.
4. See Xgen Designers Manual for detailed power ratings.
5. When powering inductive or capacitive loads, it is recommended to use a blocking diode on the output.
6. For section references above go to the Xgen Designers Manual.

## Xgen Flexibility and Signals

For detailed information please refer to the Xgen Designers' Manual which is available on-line or contact Excelsys.

### Voltage Adjustment

Output Voltage can be adjusted in a number of ways:

1. On board multi turn potentiometer
2. Remote resistive programming (via Vtrim pin)
3. Remote voltage programming (via Vtrim pin)

### Current Limit Adjustment

Output current limit can be Straight line or Foldback and can be adjusted via Itrim pin.

### Parallel Connection

To achieve increased current capacity, simply parallel outputs using the standard parallel links. Excelsys 'wireless' sharing ensures that current hogging is not possible. To parallel connect outputs:

1. Switch on IShare switch to ON on powerMods.
2. Connect Negative parallel link.
3. Adjust output voltages of powerMods to within 5mV of each other.
4. Connect Positive Parallel Link.

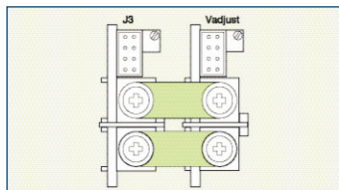

Parallel Links available to order. Part Number XP1

\*Certain applications may require military grade potentiometer or fixed resistors - consult Excelsys for details.

### Series Connection

To achieve increased output voltages, simply series outputs using standard series links, paying attention to the requirements to maintain SELV levels if required in your system.

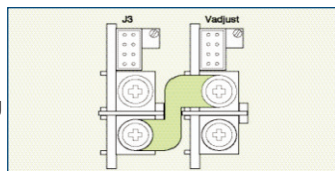

Series Links available. Part Number XS1

### Remote Sensing

When the load is remote from the power supply, the remote sense pins may be used to compensate for drops in the power leads. Where the power cabling contributes significant dynamic impedance, see Xgen series Designers' Manual.

### Bias Voltage

A SELV isolated bias (always on) voltage of 5V @ 250mA (30mA on XCE and XVE models) is provided on J2 pin 2 relative to J2 pin 1 (common) and may be used for miscellaneous control functions. 5V @ 500mA available on request.

### Inhibit/Enable

Inhibiting may be implemented either globally or on a per module basis (*powerPac* or *powerMod* inhibiting). Reverse logic (enabling) may also be implemented.

### AC Fail

Open collector signal indicating that the input voltage has failed or is less than 80Vac. This signal changes state giving 5mS of warning before loss of output regulation.

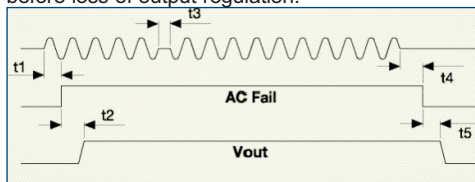

### Power Good

Opto-Isolated output signal indicates that the *powerMod* is operating correctly and output voltage is within normal band.

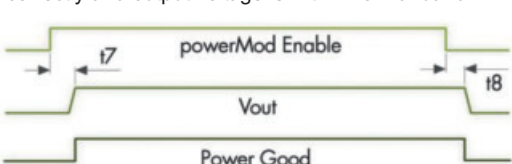

## powerPac Options

### Temperature Alarm (Option 01)

Open collector signal indicating excessive temperature has been reached due to fan failure or operation beyond ratings. This signal is activated at least 10ms prior to system shutdown.

### Fan Fail (Option 01)

Open collector signal indicating that at least one of the *powerPacs* fans has failed. This does not cause power supply shutdown. The power supply will continue to operate until 10ms after the temperature alarm signal is generated.

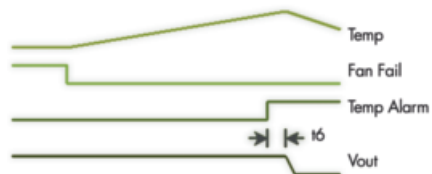

### Reverse Fan (Option 02)

The Xgen Series is available with reverse air flow direction. Contact Excelsys for derating details.

### Ultra Low Leakage Current (Option 04)

The Xgen is available with the option of Ultra Low Earth Leakage Current of <math><150\mu\text{A}</math> and is approved to EN60601-1 and UL60601-1 2nd and 3rd Editions

### Conformal Coating (Option C)

The Xgen is available with conformal coating for harsh environments and MIL-COTs applications.

### Ruggedised Option (Option R)

The Xgen is available with extra ruggedisation for applications that are subject to extremes in shock and vibration.

### Input Cable Option (Option D)

3 Wire input mains cable. Input cables are 300mm in length and come supplied with fast connectors.

### Signal Connector Pinout

| Pin | J2<br>( <i>powerPac</i> ) | J3<br>( <i>powerMod</i> )<br>Xg1-Xg5 Type A | J3<br>( <i>powerMod</i> )<br>Xg7 Type A | J3<br>( <i>powerMod</i> )<br>Xg8 Type B |
|-----|---------------------------|---|---|---|
| 1   | common                    | +sense                                      | not used                                | -pg (V2)                                |
| 2   | +5V bias                  | -sense                                      | not used                                | +pg (V2)                                |
| 3   |                           | V trim                                      | not used                                | inhibit (V2)                            |
| 4   | ac fail                   | I trim                                      | common                                  | common (V2)                             |
| 5   | fan fail*                 | +inhibit/enable                             | -pg                                     | -pg (V1)                                |
| 6   | global enable             | -inhibit/enable                             | +pg                                     | +pg (V1)                                |
| 7   | temp alarm*               | +power good                                 | inhibit                                 | inhibit (V1)                            |
| 8   | global inhibit            | -power good                                 | common                                  | common (V1)                             |

\*Option 01 only

### TYPE A Xg1-Xg7

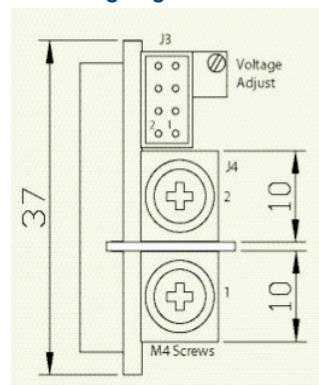

J4 Connector : M4 Screw

J3 Connector Mating Connector  
Housing: Locking Molex 51110-0860  
Non Locking Molex 51110-0850  
Crimp Terminal: Molex p/n 50394

### TYPE B : Xg8

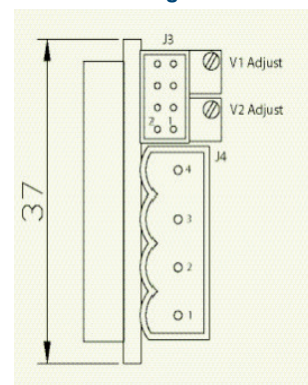

J4Connector : Camden 9200/4A  
Würth Elektronik 691 352 710 004

J3 Connector Mating Connector  
Housing: Locking Molex 51110-0860  
Non Locking Molex 51110-0850  
Crimp Terminal: Molex p/n 50394

## Xgen Product Selector

The Xgen series of user configurable power supplies with its unique plug and play architecture allows system designers to define and build 'instant' custom power solutions with industry leading 17W/in<sup>3</sup> power density and up to 90% efficiency.

### Xgen powerPacs

The application specific 4 slot and 6 slot *powerPacs* provide up to 12 isolated DC outputs from 200W up to 1340W. The table below summarises the *powerPacs* by application and power level. Please refer to the specific product datasheets for full specifications.

| Application          | Slots  | 200W | 400W | 600W | 700W | 750W | 800W | 900W | 1000W | 1200W | 1340W |
|----------------------|--------|------|------|------|------|------|------|------|-------|-------|-------|
| Standard             | 4 Slot | XLA  | XLB  | XLC  | XLD  |      |      |      |       |       |       |
|                      | 6 Slot |      | XCA  |      | XCB  |      |      |      | XCC   | XCD   | XCE   |
| Medical              | 4 Slot | XMA  | XMB  | XMC  | XMD  |      |      |      |       |       |       |
|                      | 6 Slot |      | XVA  |      | XVB  |      |      |      | XVC   | XVD   | XVD   |
| Low Noise Standard   | 4 Slot | XKA  | XKB  | XKC  |      |      |      |      |       |       |       |
|                      | 6 Slot |      | XQA  |      |      |      |      |      | XQB   | XQC   |       |
| Low Noise Medical    | 4 Slot | XRA  | XRB  | XRC  |      |      |      |      |       |       |       |
|                      | 6 Slot |      | XZA  |      |      |      |      |      | XZB   | XZC   |       |
| Ultra Quiet Standard | 4 Slot | XTA  | XTB  |      |      |      |      |      |       |       |       |
|                      | 6 Slot |      | XBA  | XBB  |      |      | XBC  |      |       |       |       |
| Ultra Quiet Medical  | 4 Slot | XNA  | XNB  |      |      |      |      |      |       |       |       |
|                      | 6 Slot |      | XWA  | XWB  |      |      | XWC  |      |       |       |       |
| Hi-Temp              | 6 Slot |      | XHA  | XHB  |      |      |      |      |       |       |       |

### Xgen powerMods

High Efficiency Plug and Play DC output modules to provide a wide range of DC output voltages from 1.0V up to 58.0V.

| MODEL  | Vmin  |      | Vnom | Vmax | Imax | Watts |
|--------|-------|------|------|------|------|-------|
|        | Vtrim | Vpot |      |      |      |       |
| Xg1    | 1.0   | 1.5  | 2.5  | 3.6  | 50A  | 125W  |
| Xg2    | 1.5   | 3.2  | 5.0  | 6.0  | 40A  | 200W  |
| Xg3    | 4.0   | 6.0  | 12.0 | 15.0 | 20A  | 240W  |
| Xg4    | 8.0   | 12.0 | 24.0 | 30.0 | 10A  | 240W  |
| Xg5    | 8.0   | 24.0 | 48.0 | 58.0 | 6A   | 288W  |
| Xg7    |       | 5.0  | 24.0 | 28.0 | 5A   | 120W  |
| Xg8 v1 |       | 5.0  | 24.0 | 28.0 | 3A   | 72W   |
|        | v2    |      | 5.0  | 24.0 | 3A   | 72W   |

Standard Xgen product options include: Conformal Coating, Low Acoustic Noise, Low Leakage Current, Extra Ruggedisation, Connector, Cabling & Mounting options, Thermal Signals and Reverse Fans.



## Configuring your Xgen

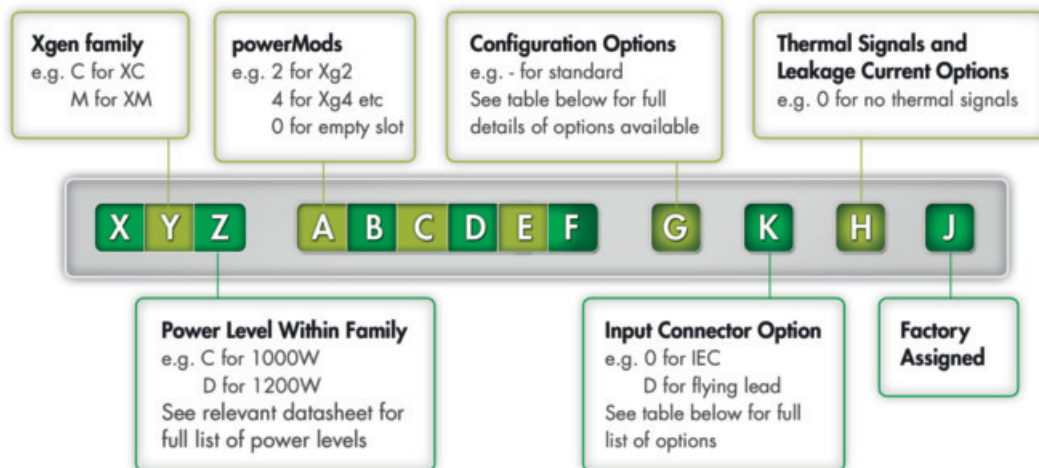

Example:  
XVD234580-D4A contains  
XVD *powerPac*:  
1200W medically approved

**Powermods**  
Xg2:5V/40A  
Xg3:12V/20A  
Xg4:24V/10A  
Xg5:48V/6A  
Xg8:24V/3A, 24V/3A

Option D: Input Cable option  
Option 4: 150µA Leakage current option

A: Factory assigned unique identifier